

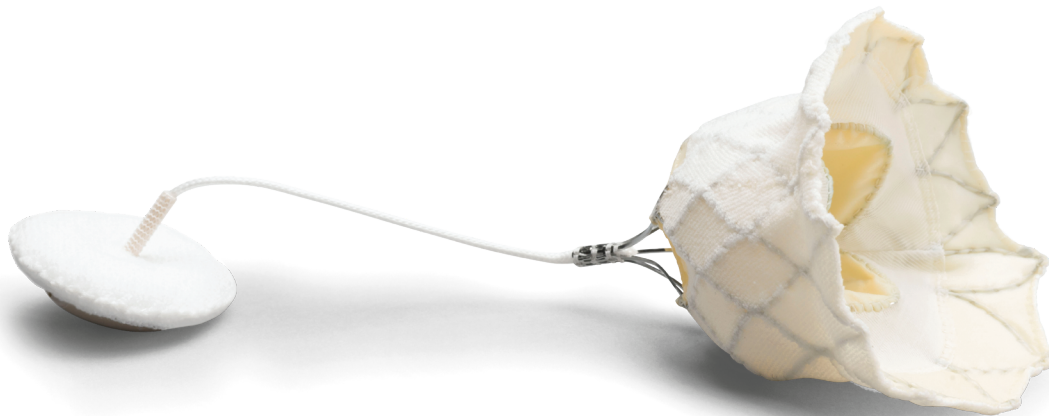

TENDYNE™ TMVI SYSTEM



INDICATIONS FOR USE

The Tendyne Mitral Valve System is indicated for the treatment of the native mitral valve without prior mitral valve intervention in patients with moderate-to-severe or severe mitral valve regurgitation (MR Grade $\geq 3+$), a life expectancy less than 5 years, left ventricular ejection fraction (LVEF) $\geq 30\%$, left ventricular end-diastolic dimension (LVEDD) ≤ 7.0 cm, who do not have severe mitral annular calcification and are deemed not suitable for surgical repair or replacement by a multi-disciplinary heart team who have:

- Primary MR and are at prohibitive surgical risk, deemed not suitable for transcatheter repair by a multidisciplinary heart team and have left ventricular end-systolic dimension (LVESD) > 3.0 cm, or
- Secondary MR and are symptomatic despite maximally-tolerated guideline directed medical therapy (including cardiac resynchronization therapy, if indicated).

DESCRIPTION

Transcatheter mitral valve implantation (TMVI) is a breakthrough technology that offers a new option for safe and effective valve replacement to patients who have symptomatic, severe mitral regurgitation (\geq grade 3+), are at high surgical risk, or have other health considerations.

Tendyne TMVI is less invasive than conventional mitral valve surgery and provides symptom relief and quality of life improvement by eliminating MR.

- Sustained MR elimination in 93% of patients at 2 years¹
- 96% technical success rate in minimally invasive procedure^{*}
- Excellent procedural safety¹
- Unique product design enabling repositioning and full retrievability intraprocedurally
- Significant improvement in symptom and quality-of-life measures¹

PRODUCT HIGHLIGHTS

The Tendyne TMVI System has been designed with the unique challenges of the mitral anatomy in mind. A beating heart procedure, there is no requirement for cardiopulmonary bypass or rapid pacing.

Valve

Dual-frame design with ability to customize fit to individual patient anatomies.

- Inner frame: Self-expanding, tri-leaflet, bioprosthetic valve
- Outer frame: Contoured design supports a secure seal within the native anatomy

Anchoring System

Tether and pad safely secure the valve.

^{*}Technical Success per MVARC.

VALVE PRODUCT SPECIFICATIONS

MODEL	Valve Number	Catalog Number	Device AP (mm)	Device IC (mm)	Device Perimeter (mm)	EOA (cm ²)
SP	33S	TENDV-SP-33S	32.5	43.5	130	3.0
	33M	TENDV-SP-33M	32.5	46.5	136	
	33L	TENDV-SP-33L	32.5	50.5	144	
	35M	TENDV-SP-35M	34.5	48.5	144	
	37S	TENDV-SP-37S	36.5	46.5	144	
	37L	TENDV-SP-37L	36.5	52.5	156	
	39M	TENDV-SP-39M	38.5	50.5	156	
	41S	TENDV-SP-41S	40.5	47.5	154	
LP	29S	TENDV-LP-29S	29.0	42.5	119	2.2
	29L	TENDV-LP-29L	29.0	47.5	129	
	33S	TENDV-LP-33S	32.5	43.5	130	
	35M	TENDV-LP-35M	34.5	48.5	144	
	37M	TENDV-LP-37M	36.5	49.5	150	

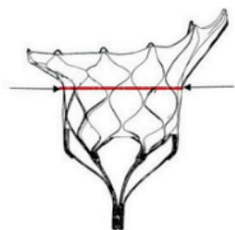

Anterior-Posterior (AP)

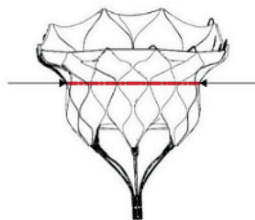

Inter-Commissural (IC)

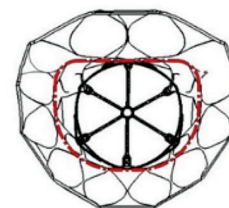

Perimeter (PER)

APICAL PAD

Catalog Number	Description
TENDV-SPAD	Tendyne Apical Pad - Small
TENDV-LPAD	Tendyne Apical Pad - Large

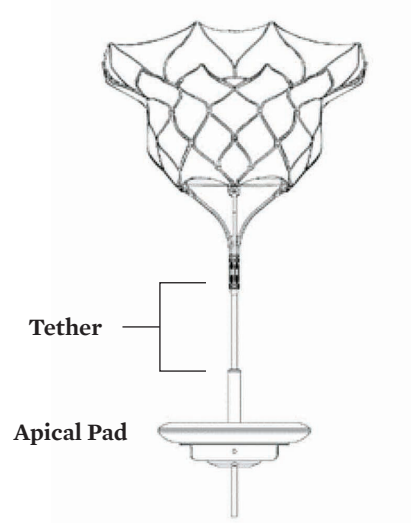
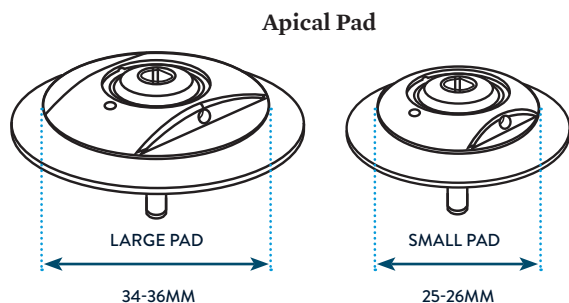

IMPLANTATION AND RETRIEVAL SYSTEM

Product Specifications

Description	Catalog Number	Approximate Dimensions (cm)
A Tendyne Loading System	TENDV-LS	18 x 9 x 61
B Tendyne Delivery System*	TENDV-DS	6.5 x 7.5 x 89
C Tendyne Pad Positioning System	TENDV-PS	5 x 7.5 x 38
D Tendyne Retrieval System*	TENDV-RS	18 x 10 x 76
Tendyne 2 Lb. Weight	TENDV-WT	N/A
Tendyne Stand	TENDV-ST	N/A
Tendyne Stand Components	TENDV-SC	N/A

*Sheath ID for the delivery system and retrieval system is 36 F.

A Loading System

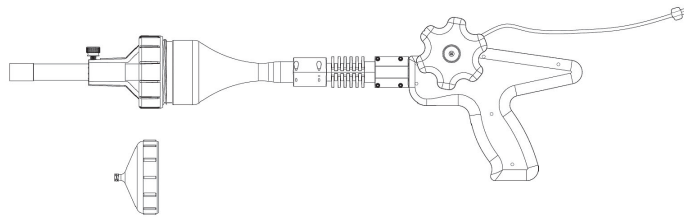

B Delivery System

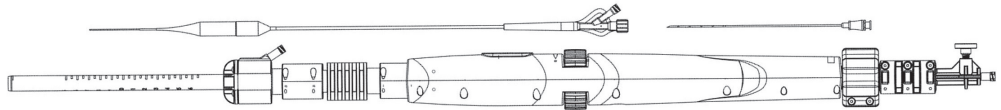

C Pad Positioning System

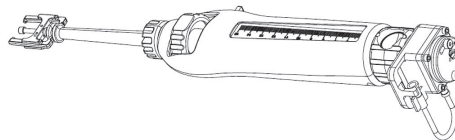

D Retrieval System

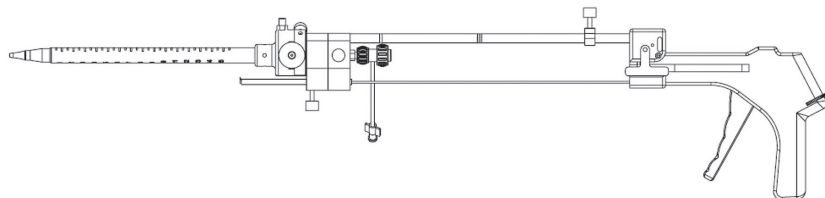

MAGNETIC RESONANCE (MR) SAFETY²

MR Conditional

Non-clinical testing has demonstrated that the valve can be scanned safely under the following conditions:

- Static magnetic field of 1.5-Tesla (1.5 T) or 3-Tesla (3 T)
- Maximum spatial gradient field of 4,000 G/cm (40.00 T/m)
- Maximum MR System reported, whole body averaged specific absorption rate (SAR) of 2.0 W/kg (Normal Operating Mode)

VALVE PACKAGING AND STORAGE²

The valve is supplied sterile and non-pyrogenic for single use only. It is sterilized with and stored in glutaraldehyde solution for preservation of porcine tissue components. The valve is supplied in a storage container with a screw cap closure and a tamper-evident seal. Store the Tendyne valve in a cool, dry environment. Do not expose the bioprosthesis to extreme low or extreme high temperature (<5°C [$<41^{\circ}\text{F}$] or $>47^{\circ}\text{C}$ [$>116^{\circ}\text{F}$]).

CAUTION: Check the temperature indicator prior to use. Do not use if the temperature indicator identifies exposure to a high or low temperature.

APICAL PAD, DELIVERY SYSTEM AND COMPONENTS PACKAGING AND STORAGE²

The Apical Pad is supplied sterile and non-pyrogenic for single use only. The Apical Pad is sterilized with ethylene oxide gas.

The Tendyne Loading System, Tendyne Delivery System, Tendyne Pad Positioning System, and Tendyne Retrieval System are supplied sterile for single use only. They are sterilized with ethylene oxide gas.

Appropriate inventory control should be maintained so that Tendyne valves, Apical Pads, Delivery Systems and system components with earlier 'USE BY' dates are used preferentially.

ADDITIONAL SYSTEM COMPONENTS

Additional system components provided sterile are single use only and include the Tendyne Stand Components (angled clip, rotating clip, rotating clip head, bottom loading clip, thumb screws), 1-way and 3-way stopcocks, hemostasis adapter, Tuohy- Borst valve, valve pocket de-air tube, tether flushing assembly, verification tether, extension tube, tether clip, and pressure transducer. They are sterilized with ethylene oxide gas.

STATEMENT ON THE USE OF LATEX

The Tendyne Mitral Valve System product and packaging do not contain latex materials.³ Abbott Structural Heart finished goods are tested by an independent laboratory and in accordance with ISO 10993-10:2010 Biological Evaluation of Medical Devices – Tests for Irritation and Delayed-type Sensitivities. Compliance with this standard entails animal testing under extraction conditions that exaggerate conditions of clinical use. As this testing accounts for all specified materials, environments of exposure and inherent processing, Abbott Structural Heart remains confident that no latex proteins are included in the constituent materials nor introduced during processes that comprise the finished device and packaging.

REFERENCES

1. Muller D, et al. Two-year outcomes of Tendyne transcatheter mitral valve implantation to treat symptomatic, severe mitral regurgitation. Presented at: PCR E-Course, June, 2020.
2. Tendyne Mitral Valve System IFU
3. Abbott Data on File.

CAUTION: This product is intended for use by or under the direction of a physician. Prior to use, reference the Instructions for Use, inside the product carton (when available) or at eifu.abbottvascular.com or at medical.abbott/manuals for more detailed information on Indications, Contraindications, Warnings, Precautions and Adverse Events.

Information contained herein for **DISTRIBUTION outside of the U.S. ONLY**. Check the regulatory status of the device in areas where CE marking is not the regulation in force.

Illustrations are artist's representations only and should not be considered as engineering drawings or photographs.

Abbott

Park Lane, Culliganlaan 2b, 1831 Diegem, Belgium, Tel: +32 2 714 14 11
www.cardiovascular.abbott

[™] Indicates a trademark of the Abbott group of companies.

[‡] Indicates a third party trademark, which is property of its respective owner.

© 2020 Abbott. All Rights Reserved.

MAT-2001517 v2.0 | Item approved for OUS only.

